

Product Description

- ◆ MOSFET Output
- ◆ Control Voltage: 5VDC, 12VDC, 24VDC
- ◆ Load Current: 2A, 3A, 4A, 5A
- ◆ Dielectric Strength: 2500Vrms
- ◆ RoHS Compliant
- ◆ Optional socket, rail mounting

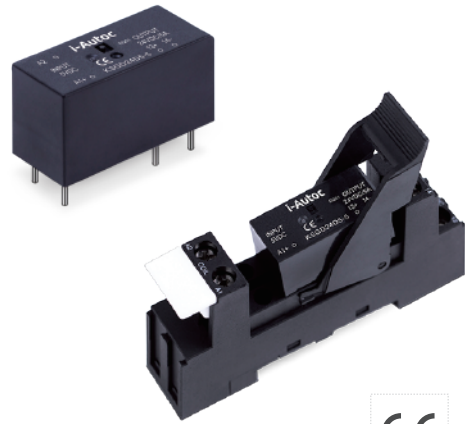

Ordering Information

KSGD	48	D	2	-5	D	(XXX)
KSGD Series ⁽¹⁾	Load Voltage 24: 0-28.8VDC 48: 0-36VDC	DC Control	Load Current 2: 2Amp 3: 3Amp 4: 4Amp 5: 5Amp	Control Voltage 5: 5VDC 12: 12VDC 24: 24VDC 48: 48VDC 60: 60VDC	Blank: without socket D: with socket	Customized Code

(1)Part numbers available are listed in the table below.

	2A	3A	4A	5A
5VDC	KSGD24D2-5(D)	KSGD24D3-5(D)	KSGD24D4-5(D)	KSGD24D5-5(D)
	KSGD48D2-5(D)	KSGD48D3-5(D)	KSGD48D4-5(D)	KSGD48D5-5(D)
12VDC	KSGD24D2-12(D)	KSGD24D3-12(D)	KSGD24D4-12(D)	KSGD24D5-12(D)
	KSGD48D2-12(D)	KSGD48D3-12(D)	KSGD48D4-12(D)	KSGD48D5-12(D)
24VDC	KSGD24D2-24(D)	KSGD24D3-24(D)	KSGD24D4-24(D)	KSGD24D5-24(D)
	KSGD48D2-24(D)	KSGD48D3-24(D)	KSGD48D4-24(D)	KSGD48D5-24(D)
48VDC	KSGD24D2-48(D)	KSGD24D3-48(D)	KSGD24D4-48(D)	KSGD24D5-48(D)
	KSGD48D2-48(D)	KSGD48D3-48(D)	KSGD48D4-48(D)	KSGD48D5-48(D)
60VDC	KSGD24D2-60(D)	KSGD24D3-60(D)	KSGD24D4-60(D)	KSGD24D5-60(D)
	KSGD48D2-60(D)	KSGD48D3-60(D)	KSGD48D4-60(D)	KSGD48D5-60(D)

General Specifications

Input Specifications (Ta=25°C)		
Control Voltage Range	5	4-6VDC
	12	9.6-14.4VDC
	24	19.2-28.8VDC
	48	38.4-57.6VDC
	60	48-72VDC
Must Turn-on Voltage	5	4VDC
	12	9.6VDC
	24	19.2VDC
	48	38.4VDC
	60	48VDC
Must Turn-off Voltage		1VDC
Maximum Input Current		25mA

General Specifications

Output Specifications (Ta=25°C)

Load Voltage Range	24VDC	0-28.8VDC
	48VDC	0-36VDC
Load Current Range	2A	0.02-2A
	3A	0.02-3A
	4A	0.02-4A
	5A	0.02-5A
Maximum Transient Overvoltage	24VDC	60Vpk
	48VDC	75Vpk
Internal TVS Protection	24VDC	37.1-41VDC
	48VDC	64.6-71.4VDC

Maximum Surge Current (@10 ms)	2A	20Apk
	3A	30Apk
	4A	40Apk
	5A	50Apk
Maximum Turn-on Time		1ms
Maximum Turn-off Time		1ms
Maximum Off-State Leakage Current@Rated Load Voltage		0.1mA
Maximum On-State Voltage Drop@Rated Current		0.3VDC

General Specifications (Ta=25°C)

Dielectric Strength (50/60Hz)		2500Vrms
Minimum Insulation Resistance (@500VDC)		1000MΩ
Ambient Temperature Range		-30°C ~ +80°C
Storage Temperature Range		-30°C ~ +100°C
Weight (Typical)	without socket	15g
	with socket	50g

Applications

Suitable for DC motor, electromagnetic valve, electromagnet control, and etc.

Outline Dimensions

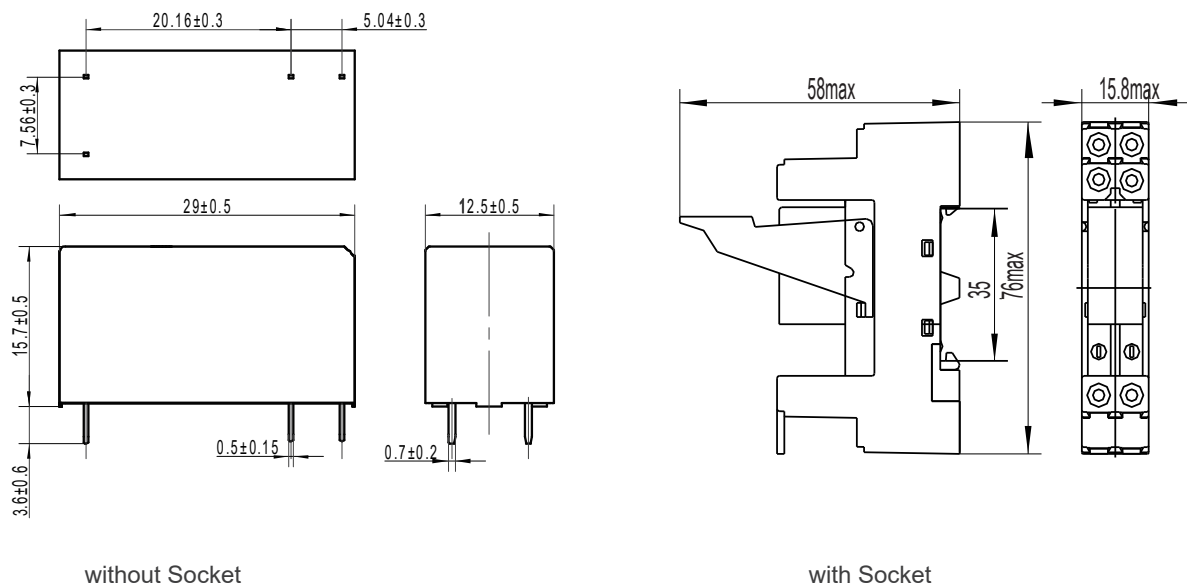

Wiring Diagram

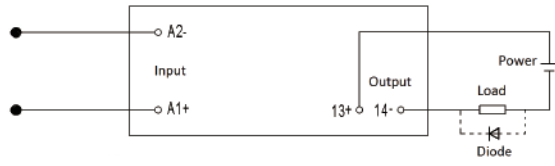

without socket

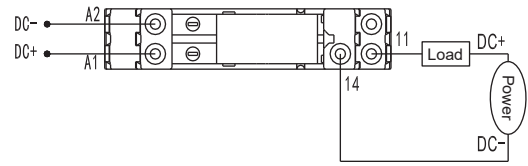

with socket

Thermal Derating Curve

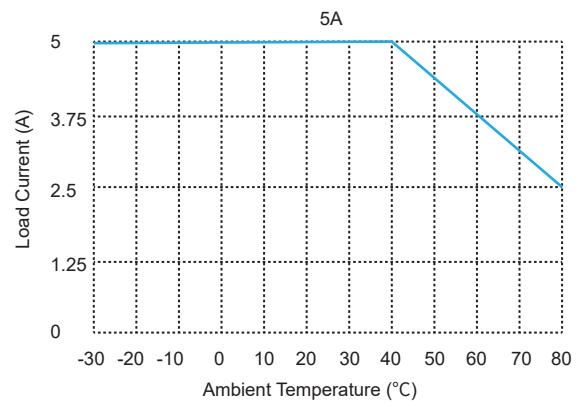
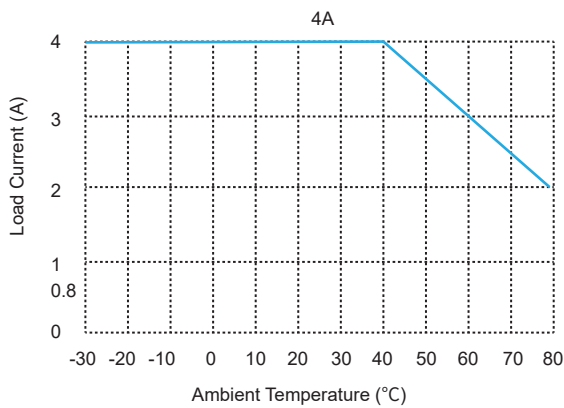
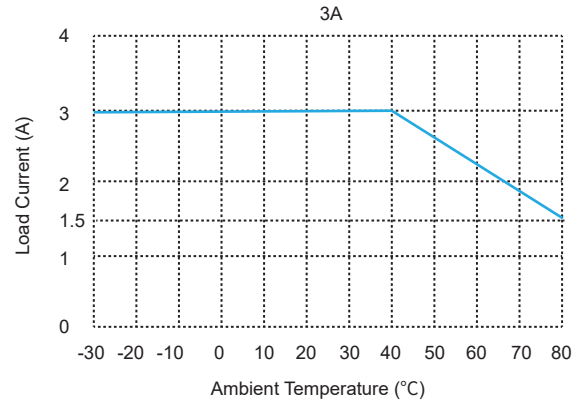
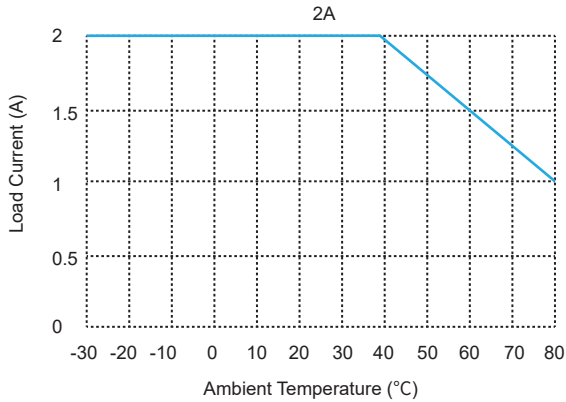

General Notes

1. Soldering must be finished within 10 seconds at 260°C, or finished within 5 seconds at 350°C. Otherwise it may cause damage to the relay.
2. Terminal polarity must be observed. Otherwise it may cause damage to the relay.
3. When ambient temperature is above 25°C, the maximum load current decreases. See thermal derating curve.
4. Capacitive load will produce very high surge current at the moment of conduction, which may lead to the damage of solid state relay due to the excessive surge current. Therefore, if the actual load is capacitive, or the load has paralleled large capacitance, it is strongly recommended that NTC should be connected in series in the load loop to suppress surge current in order to avoid damage to the product.

Warnings

1. The product's side panels may be hot, allow the product to cool before touching.
2. Disconnect all power before installing or working with this equipment.
3. Verify all connections and replace all covers before turning on power.